

### Features

- Single handle controls both on/off activation and temperature settings.
- Trim includes push button diverter.
- Includes single-function 2.5 gpm (9.5 lpm) showerhead with Katalyst® air-induction technology.
- MasterClean™ sprayface features an easy-to-clean surface that withstands mineral buildup.
- High-temperature limit stop allows you to preset a comfortable maximum temperature to eliminate scalding.
- Complements Purist faucets and accessories.
- Rite-Temp® pressure-balancing technology maintains water temperature within +/- 3°F.

### Material

- Premium material construction for durability and reliability.
- KOHLER finishes resist corrosion and tarnishing.

### Installation

- Trim only; requires valve to complete installation (sold separately).

### Required Products/Accessories

K-11748 Series Rite-Temp® Valves

### Recommended Products/Accessories

K-23723 Faucet cleaner

### Optional Products/Accessories

1016154 Rite-Temp® Deep Rough-In

88526 Thin Wall Trim Kit



### Codes/Standards









ASME A112.18.1/CSA B125.1  
DOE - Energy Policy Act 1992

### KOHLER® Faucet Lifetime Limited Warranty

See website for detailed warranty information.

### Available Colors/Finishes

*Color tiles intended for reference only.*

Color	Code	Description
	CP	Polished Chrome
	SN	Vibrant® Polished Nickel
	PGD	Vibrant® Moderne Polished Gold
	BGD	Vibrant® Moderne Brushed Gold
	BN	Vibrant® Brushed Nickel
	BV	Vibrant® Brushed Bronze
	BL	Matte Black
	2MB	Vibrant® Brushed Moderne Brass

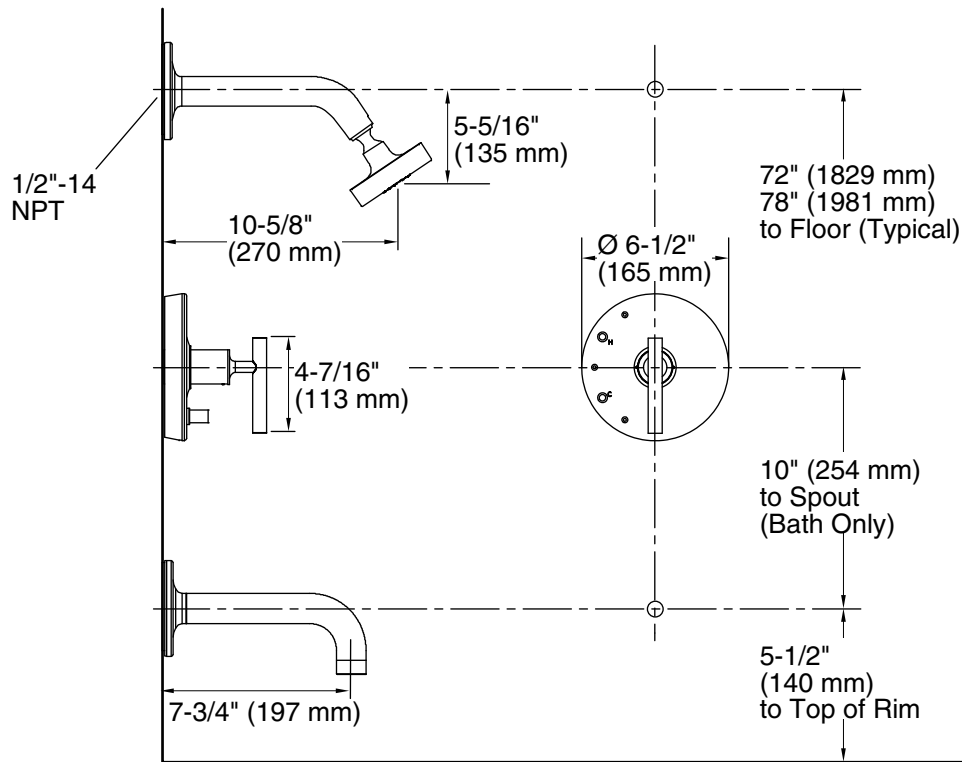

### Technical Information

All product dimensions are nominal.

Drain included: No

### Showerhead/Body Spray:

Rated maximum flow: 2.5 gal/min (9.5 l/min)

Pressure: 80 psi (5.5 bar)

### Notes

Install this product according to the installation guide.

Avoid cross-flow conditions. Do not install shut-off device on either valve outlet.

Cap the shower outlet if deck-mount spout, diverter, or handshower is connected to the spout outlet.